

Scott Kinney

PORTFOLIO

KINNEYDESIGN.COM

404-725-5176

SCOTT@KINNEYDESIGN.COM





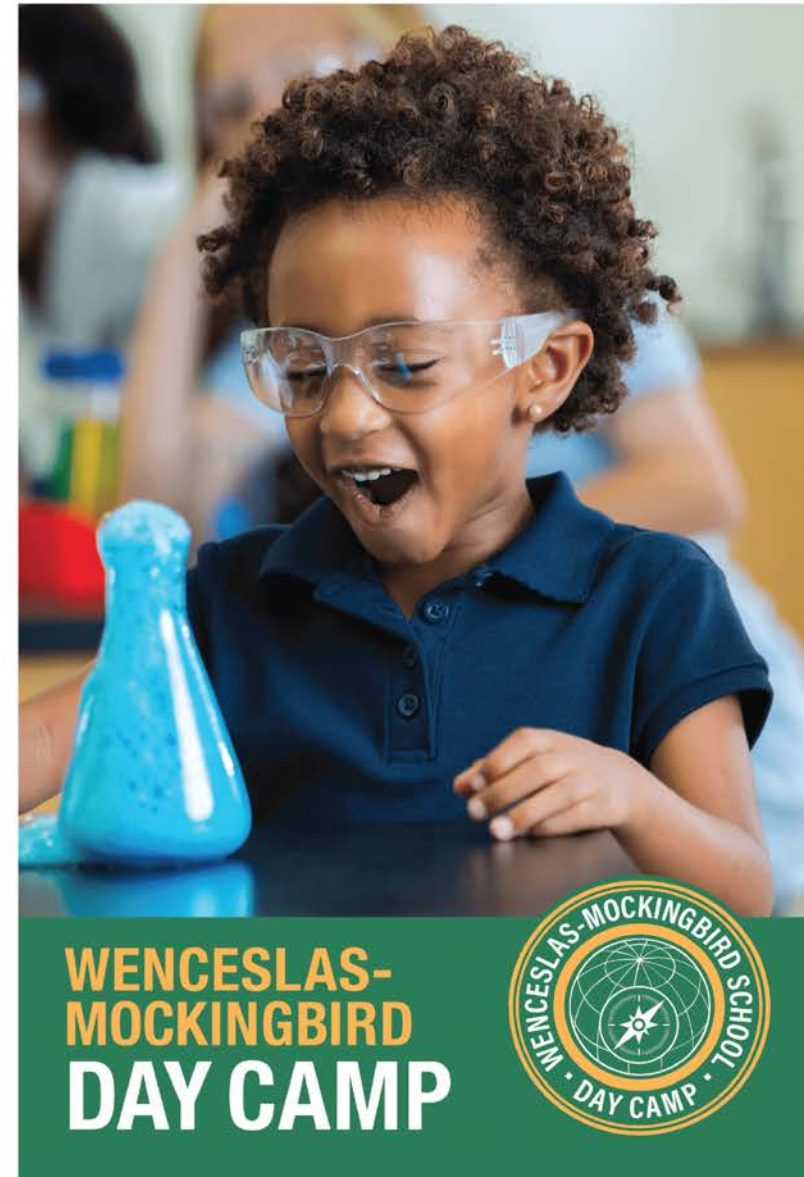

WENCESLAS-MOCKINGBIRD
DAY CAMP









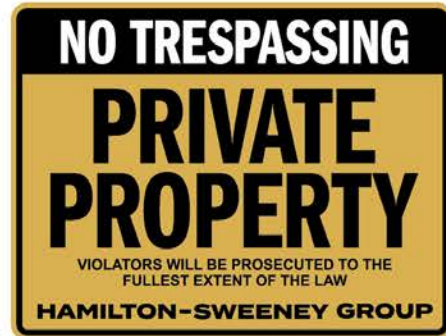



ALTERNATE CONCEPTS

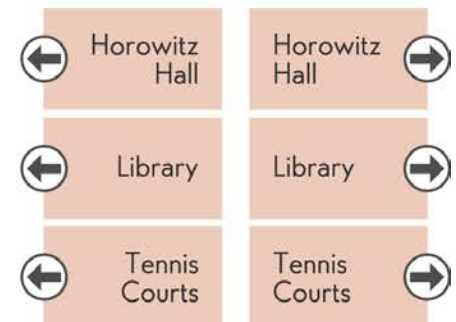
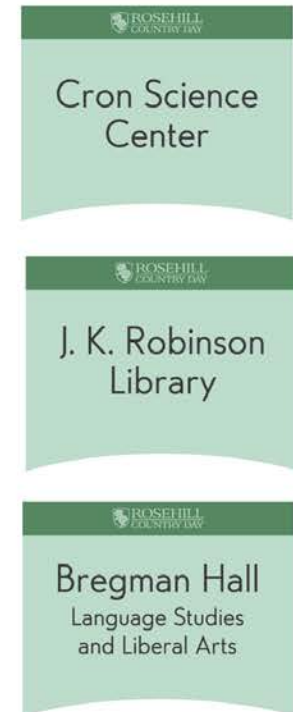
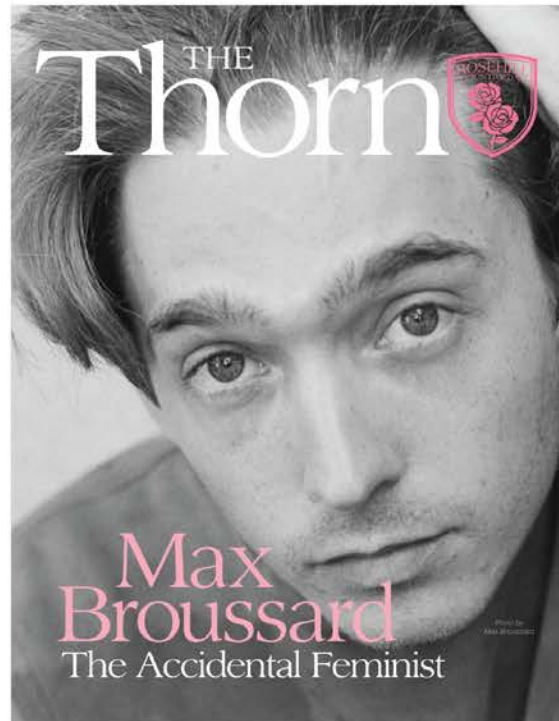

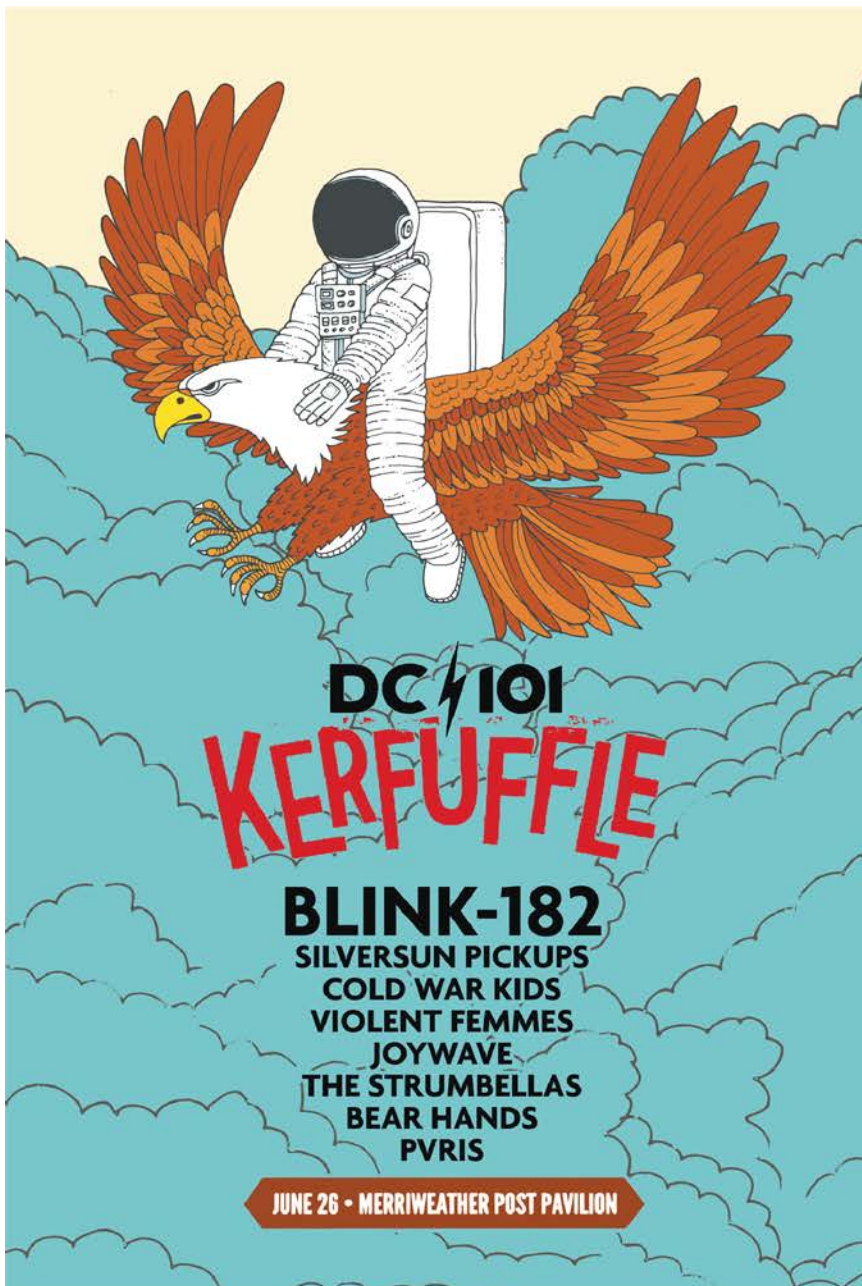



*Sleepy
Time*

The logo for 'Sleepy Time' features the words 'Sleepy' and 'Time' in a large, red, cursive font. The text is surrounded by several teal stars and a teal crescent moon.

PHONE FA 8-1171
TELETYPE 8800

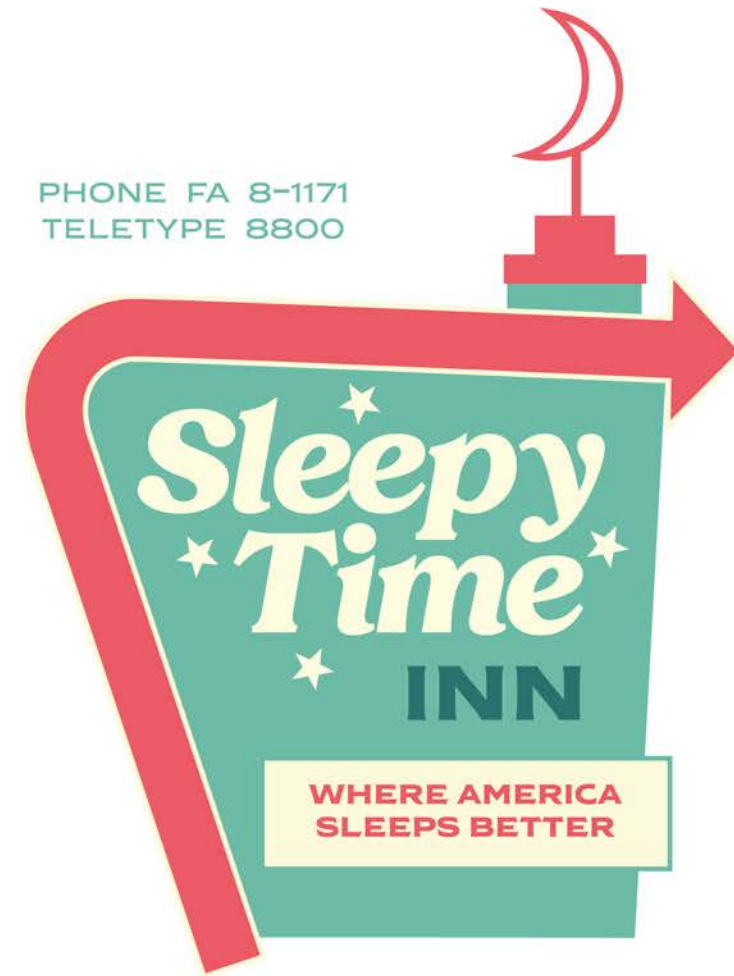

4200 E. PALM CANYON DR.
PALM SPRINGS, CALIFORNIA



Alicia
Lozada
★ ★ ★ ★ ★ MAYOR





NEW!

POWER STEERING

HYDRAULIC BRAKES

SALE!

6-OR-8 CYLINDERS

SAFE BUY



"BE SMART... BUY FROM CLARK'S"

ATTRACTIVE PRICES • EASY TERMS

BUY • SELL • TRADE • SERVICE & REPAIR



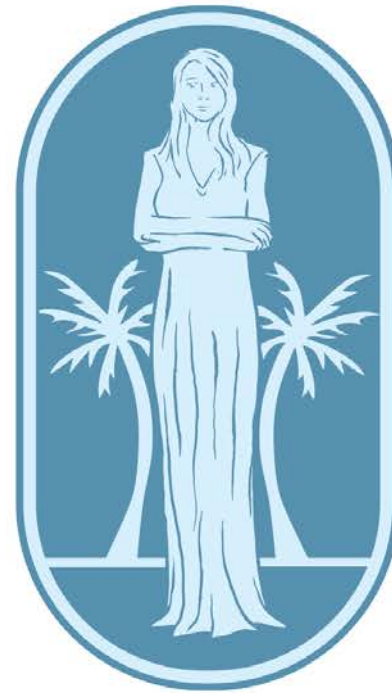

HEAVENLY
PALMS
REHABILITATION CENTER • SPA





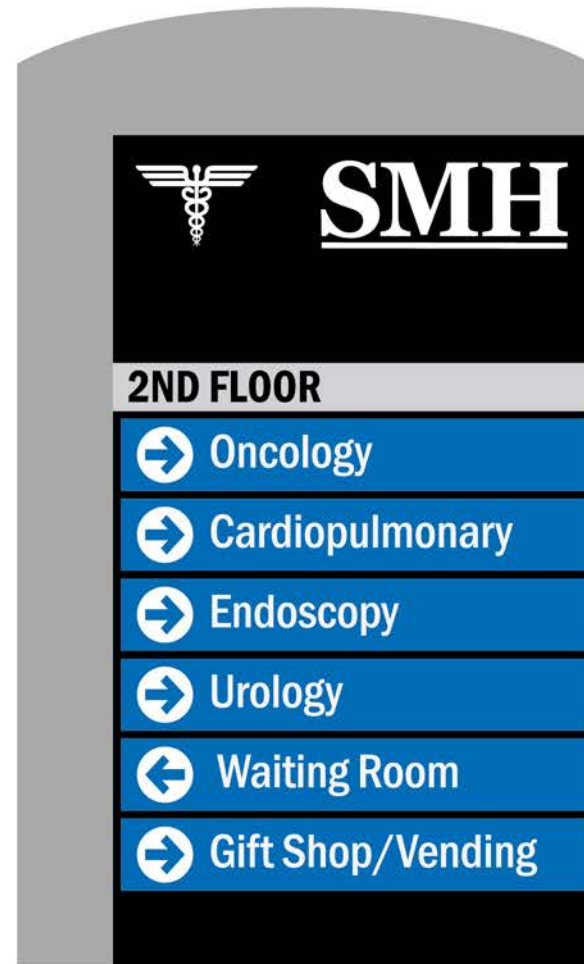
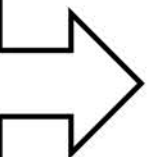
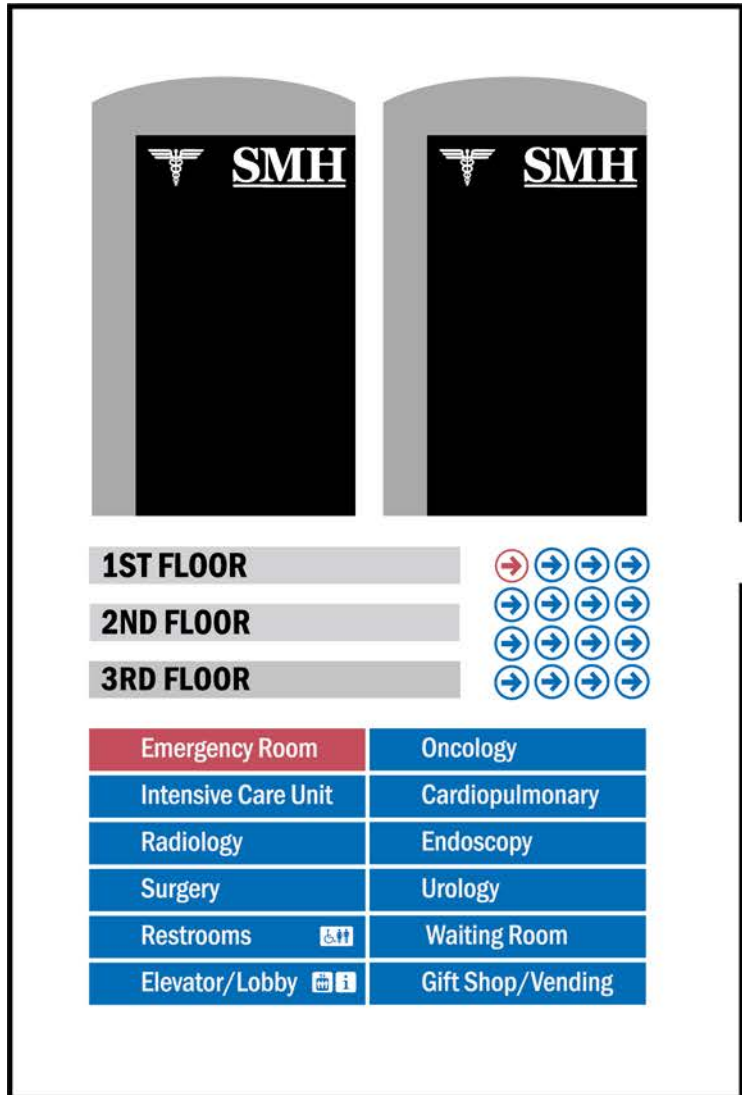

SATURDAY 9AM-12PM

Flower Show



ENTRIES 7:30AM-9:00AM	JUDGING: 9:00AM-11:30AM	CATEGORY AWARDS: 11:30AM-12:00PM
---------------------------------	-----------------------------------	--

SPONSORED BY:

FRIEDMAN'S
HARDWARE
SERVING WARREN COUNTY FOR OVER 60 YEARS

COUNTY LINE
FEED AND SEED

The MAGIC of LOUIS LETERRIER



SHOWTIMES

8:30 AM	10:30 AM	12:30 PM	2:30 PM	4:30 PM	6:30 PM
----------------	-----------------	-----------------	----------------	----------------	----------------

Guaranteed
TO DELIGHT & AMAZE

SOLD HERE

ONLY
The Best
FOR YOUR
BABY



NURSERY FURNITURE
by
Hemingway

Lenox • NEWSSTAND •
24 HRS.

Dependable Quality



NORTHCOTT
BRAND TIRES

American Made Durable

Two Al's **VARIETY**

LEATHER JACKETS
SUEDE JACKETS
SHOES & BOOTS
HAMBAGS
DRESSES & MORE



QUALITY TOOLS
CULP - THE BEST IN YOUR TOOL BOX

AVAILABLE HERE

Cathell
Fine Furniture
"THE MARK OF VALUE AND QUALITY"

USE OUR
Layaway
PLAN

- As low as 50¢ down holds any item
- Take 90 days to pay
- Easy, agreeable terms
- Take advantage of today's prices



RUBY'S

NEW *Fine Furniture* USED

MUST BE AT LEAST
42"
 TO RIDE

THIS RIDE
 TAKES
2
TICKETS

Ride Coupons **\$1.25** Ride Coupons
 PER COUPON

120 COUPONS: \$100
SAVE \$50.00

55 COUPONS: \$50
SAVE \$18.76

21 COUPONS: \$20
SAVE \$6.25

BEST DEAL TODAY
UNLIMITED RIDES
\$30.00

ALL RIDES REQUIRE MORE THAN ONE (1) COUPON EACH

PRIZE EVERY TIME

NO SINGLE RIDERS

This Ride For Children Only

YOU MUST BE THIS TALL ↓

LIVESTOCK EXHIBITION
 Sat. 1 P.M.

TRACTOR RACING
 SAT 4PM
 SUN 1PM

KNOWLEDGE IS POWER AND YOU NEED IT EVERY HOUR
READ A BOOK 101

NATIONAL MEMORIAL AFRICAN BOOK STORE
Harlem's Cultural and Educational Institution
THIS HOUSE IS PACKED WITH ALL THE FACTS ABOUT ALL THE BLACKS ALL OVER THE WORLD
SEEING IS BELIEVING - COME SEE
IF FOR ABOUT OR AMONG AFRO-AMERICANS
CHECK US OUT AND WE'LL TELL YOU WHAT IT'S ALL ABOUT!

WHEN YOU KNOW THE TRUTH YOU HAVE THE KEY THAT WILL SET YOU FREE
READ A BOOK 101

THE HOUSE OF COMMON SENSE AND HOME OF PROPER PROPAGANDA

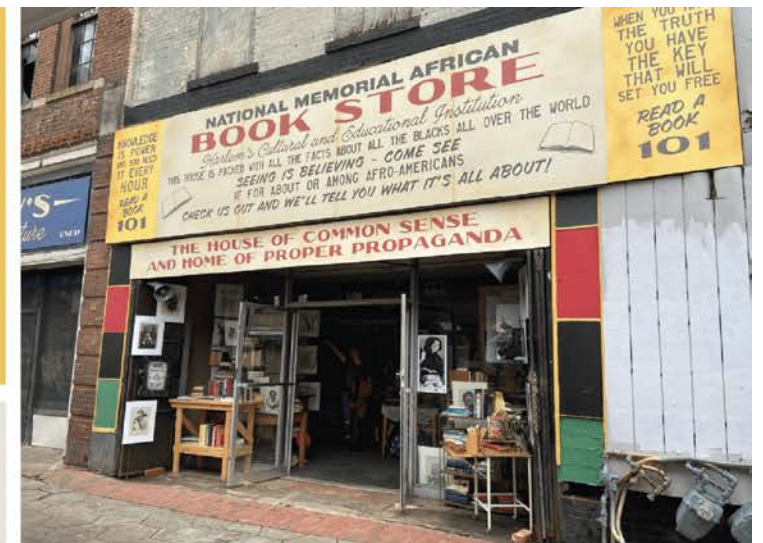

6223 East 4th Street

COPY & PHOTO CENTER

**BLACK & WHITE COPIES * COLOR COPIES • PASSPORT PHOTOS
FAX SERVICE * PHOTO & FILM DEVELOPING * NEGATIVE SCANS**

THANK YOU FOR YOUR BUSINESS

NEXT DAY PROCESSING \$16.99!	24 Hour High Quality Prints	<i>Printing</i> POSTERS FLYERS ENLARGEMENTS POSTCARDS BANNERS
Print	Black & White Copies	ASK ABOUT OUR PHOTO Club - 5% OFF ALL DEVELOPING - 1/2 OFF RE-PRINTS - EARN FREE ROLLS OF FILM
Fax Service	COLOR COPIES	
Laminating	Reprints	Blueprint COPIES MADE HERE
Scan	Banner	
Passport Photo	Enlargements	
Binding	Posters	



MENTION THIS AD FOR A FREE WAFFLE ON US!

SHORTY'S BISCUITS & WAFFLES

Serving Breakfast All Day!

"Putting good food in your mouth since 1948!" 

Mon-Fri 6:30am-2:30pm
Sat 6:30am-1:00pm
Sun 7:30am-2:30pm

Family Owned Since 1923

Campolieti's ITALIAN RESTAURANT



BUON APPETITO!

"All you can eat" pasta every Thursday night!

ICE CREAM • ICE COLD BEER DELI • GROCERY • CIGARETTES • SNACKS • MONEY ORDERS • MAGAZINES

DELI • GROCERY **BAO'S** DELI AND GROCERY

NEW YORK LOTTO

ATM • FROZEN FOODS ATM | FROZEN FOODS | FRESH MEATS **NEW YORK LOTTO**

MONEY ORDERS • MAGAZINES COLD BEER & SODA • ICE CREAM • DELI • GROCERY • CIGARETTES • SNACKS



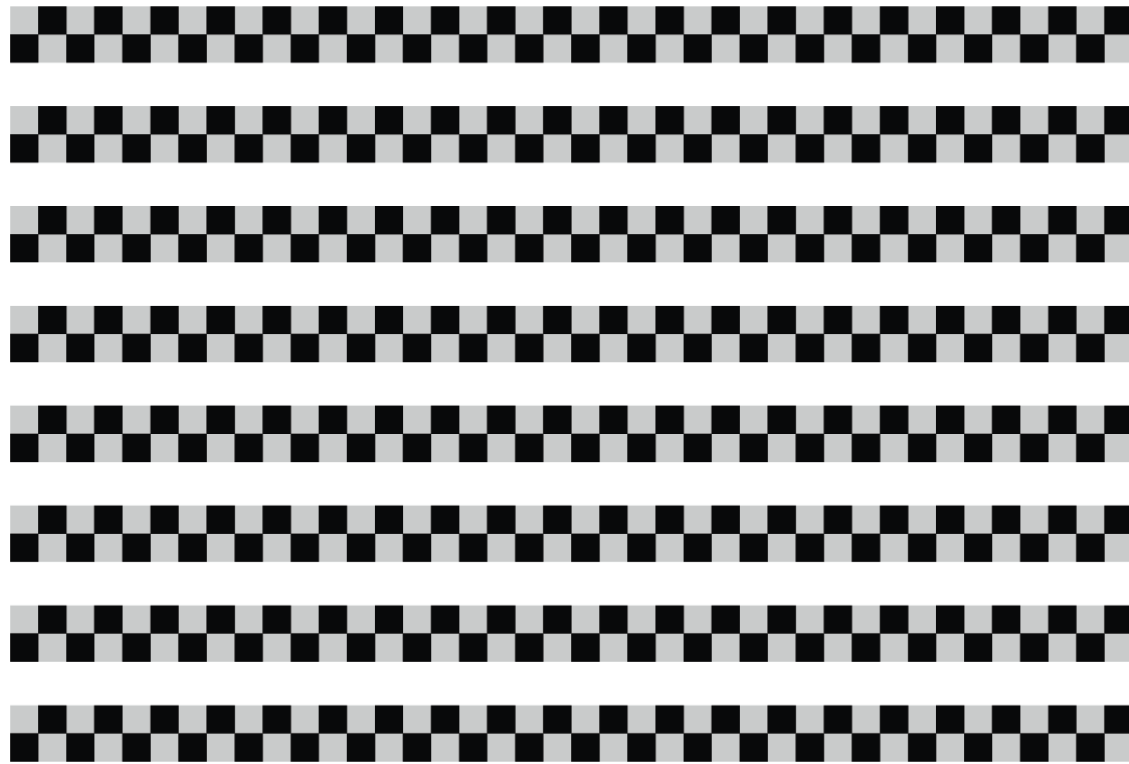

RATES

25¢ FIRST **1/5** MILE

5¢ EACH ADDITIONAL

5¢ PER 90 SEC. NOT IN MOTION

RATES

25¢ FIRST **1/5** MILE

5¢ EACH ADDITIONAL

5¢ PER 90 SEC. NOT IN MOTION

TAXI
CAB *Service*

TAXI
CAB *Service*

46¢ FIRST 1/5 MILE
10¢ EACH ADD. 1/5 MILE
 10¢ PER 2 MIN. TIME NOT IN MOTION

46¢ FIRST 1/5 MILE
10¢ EACH ADD. 1/5 MILE
 10¢ PER 2 MIN. TIME NOT IN MOTION

SERVING ALL OF DETROIT

SERVING ALL OF DETROIT

AIR CONDITIONING

AIR CONDITIONING

⚡ RADIO DISPATCHED ⚡

⚡ RADIO DISPATCHED ⚡

DURHAM'S
TAXI CO.

DURHAM'S
TAXI CO.

↓ SECURITY ENTRANCE ↓

SECURITY ENTRANCE
←

SECURITY ENTRANCE
→

VISITORS
PLEASE USE MAIN ENTRANCE AND REGISTER IN OFFICE

NOTICE
ALL BAGS SUBJECT TO SEARCH

NOTICE
ALL BAGS SUBJECT TO SEARCH

NO TRESPASSING
BY UNAUTHORIZED PERSONS DURING AND AFTER SCHOOL HOURS
VIOLATORS WILL BE PROSECUTED

NO TRESPASSING
BY UNAUTHORIZED PERSONS DURING AND AFTER SCHOOL HOURS
VIOLATORS WILL BE PROSECUTED

NO FIREARMS OR WEAPONS
ALLOWED ON SCHOOL PROPERTY
 
VIOLATORS WILL FACE SEVERE FEDERAL, STATE AND LOCAL CRIMINAL PENALTIES

NO FIREARMS OR WEAPONS
ALLOWED ON SCHOOL PROPERTY
 
VIOLATORS WILL FACE SEVERE FEDERAL, STATE AND LOCAL CRIMINAL PENALTIES

VISITORS
PLEASE USE MAIN ENTRANCE AND REGISTER IN OFFICE

WEIGHT ROOM RULES
• Do not use equipment without supervision
• No food or drink permitted in this area
• No chewing gum
• No jewelry
• Proper athletic attire required
• Collars must be used with all free weights
• Weights must be placed on racks after use

DON'T CUT IN THE LUNCHLINES

NO STUDENT MAY USE THE WEIGHT ROOM WITHOUT PROPER TEACHER SUPERVISION

NO SKATEBOARDING ON SCHOOL PROPERTY

NO SKATEBOARDING ON SCHOOL PROPERTY

NO SKATEBOARDING ON SCHOOL PROPERTY

SECURITY NOTICE
 METAL DETECTOR SCREENING REQUIRED BEFORE ENTRY

ENTER THROUGH SECURITY ENTRANCE
→

DRUG-FREE SCHOOL ZONE

DRUG-FREE SCHOOL ZONE

WARNING
 SECURITY PATROL IN OPERATION

WARNING
 SECURITY PATROL IN OPERATION

WARNING
 SECURITY PATROL IN OPERATION

NO TRESPASSING
BY UNAUTHORIZED PERSONS DURING AND AFTER SCHOOL HOURS
VIOLATORS WILL BE PROSECUTED

NO TRESPASSING
BY UNAUTHORIZED PERSONS DURING AND AFTER SCHOOL HOURS
VIOLATORS WILL BE PROSECUTED

STOP BULLYING SAFE SCHOOL ZONE

STOP BULLYING SAFE SCHOOL ZONE

STOP BULLYING SAFE SCHOOL ZONE

SECURITY NOTICE
 METAL DETECTOR SCREENING REQUIRED BEFORE ENTRY



ORDER of SERVICES

SUNDAY SCHOOL	9:30 AM
SUNDAY SERVICE	12:30 PM
EVENING SERVICE	5:30 PM
FRIDAY PRAYER AND BIBLE STUDY	7:30 PM

"THE LORD IS MY SHEPHERD AND I SHALL NOT WANT"
-PSALMS 23rd

Divine Cavalry of the Holy Ghost
LUCRECIA ROBINSON, PASTOR
PH. 347-179-5723 PRAYER LINE 347-183-7729
CHURCH OF NEW YORK







Henry Ford Hospital

↑

Radiology / X-ray

Stairs →

Elevators →

1st Floor

- ← Main Entrance
- Emergency Dept.
- Radiology / X-ray
- Cardiology Unit
- ← Maternity
- ← Pathology
- ← Endoscopy
- ← Administration

HOSPITAL STAFF ONLY BEYOND THIS POINT

NO MATCHES
NO LIGHTER
THANK YOU

1st Floor

EMERGENCY DEPT.

- Admission / Triage
- ↑ Trauma 1 & 2
- ↑ Surgery
- ↑ Intensive Care
- ↑ Radiology / Xray
- Maternity
- Main Hospital

1st Floor

EMERGENCY DEPT.

- ↓ Trauma 1 & 2
- ↓ Surgery
- Admission / Triage
- ↑ Intensive Care
- ← Radiology / Xray
- Maternity
- Main Hospital

- RECOVERY 1
- RECOVERY 2
- RECOVERY 3
- RECOVERY 4
- RECOVERY 5
- RECOVERY 6
- RECOVERY 7
- RECOVERY 8
- RECOVERY 9
- TRIAGE 1
- STAIRS
- NURSE
- RESTROOMS
- DIALYSIS
- TRIAGE 2
- TRIAGE 3
- NO SMOKING IN HOSPITAL

CAUTION

DOORS OPEN OUT

Henry Ford Hospital

DIRECTORY

1st Floor	3rd Floor
Main Entrance	Psychiatry
Emergency Dept.	Maternity
Radiology / X-ray	Physical Therapy
Respiratory	Administration
Pharmacy	Human Resources
4th Floor	
Gift Shop	Rooms 400 - 450
Cafeteria	Patient Records
2nd Floor	
Surgery Wing	Chapel
5th Floor	
Pathology	Endoscopy
Clinic	Lab
Intensive Care Dept.	Lab
Cardio Pulmonary	Patient Rooms 500 - 550

Family Waiting Area

- 1 LINENS
- 2 STORAGE
- 3 HOSPITAL STAFF ONLY
- 4 STORAGE
- 5 HOSPITAL STAFF ONLY
- 6 NO ADMITTANCE
- 7 DO NOT ENTER
- 8 DO NOT ENTER
- 9 STERILIZATION ROOM
- 10 STAND BACK
- DOORS MAY OPEN AT ANY TIME
- 11

Caution: Keep Doors Clear

↑ EMERGENCY ↑

Emergency

Triage / Admission ←
EXIT to Ambulance Bay ↑

DEPOSIT HAZARDOUS WASTE ↓

HOME OF THE
NEW YORK 4TH OF JULY SPECTACULAR

WONDERFUL
J. YUENG, PROP.
Pyrotechnics

GOD BLESS AMERICA!

HOME OF THE
NEW YORK
4TH OF JULY
SPECTACULAR





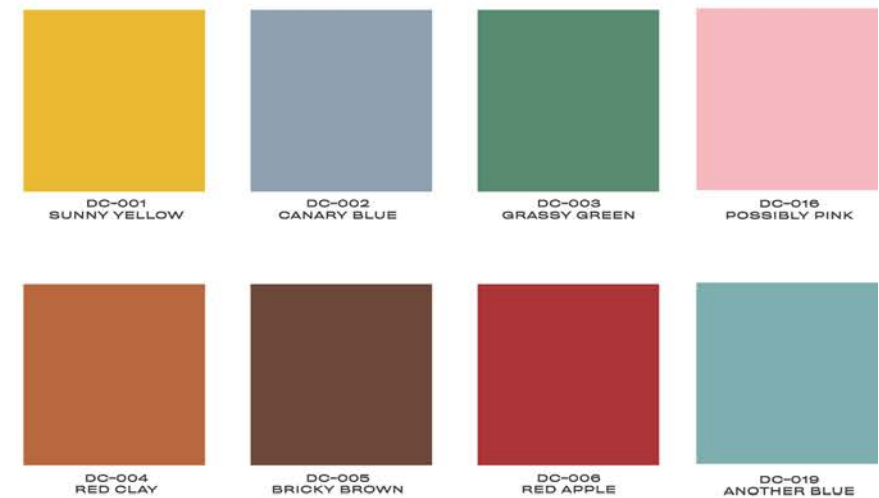



Professional Series



Quality Automotive Parts Since 1933



MADE IN INDONESIA

Fuel Pump

Premium Remanufactured Fuel Pump
Bomba de combustible remanufacturada Premium

BA33721

Contents 1 Piece
017-4106-2





Fuel Pump

Premium Remanufactured Fuel Pump
Bomba de combustible remanufacturada Premium



MADE IN MALAYSIA / ASSEMBLED IN MEXICO



MECHANICAL FUEL PUMP / BOMBA DE COMBUSTIBLE MECANICA

\$263.00 USD

BA33721 453-234



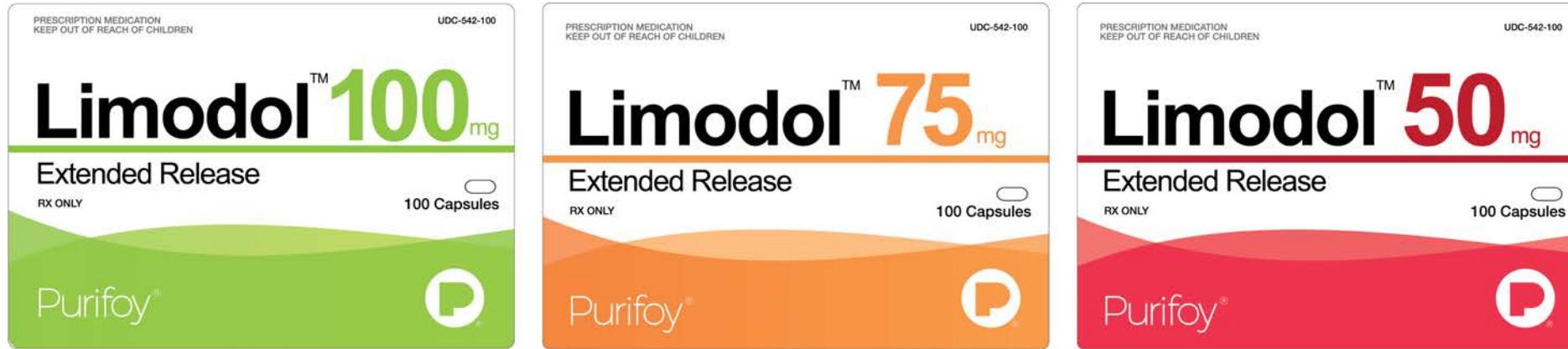



CUSTOMER RECEIPT **PHOTOS** **411085** **KEEP THIS TICKET**

East 4th St. Copy & Photo Center
6223 East 4th Street
New York, NY 10003
212-166-0871

Claim ticket is required to pick up your order. Completed orders will be held for 30 days. Processing center is not responsible for content of images. Prints may be inspected by technician for quality assurance. ORIGINAL FILM ROLL WILL NOT BE RETURNED. STORE NEGATIVES IN A COOL, DRY LOCATION.

TEAR ALONG PERFORATION TO REMOVE

PHOTOS

1 ROLL PER ENVELOPE PLEASE

1 Last name initial	2 CUSTOMER INFORMATION:		ORDER #
	First Name: _____ Last Name: _____ Phone #: _____		411085
3 NUMBER OF EXPOSURES	4 QUANTITY OF EACH PRINT	5 PRINT SIZE	6 SURFACE
<input type="checkbox"/> 12 - 15 <input type="checkbox"/> 24 - 28 <input type="checkbox"/> 36 - 40	<input type="checkbox"/> SINGLE SET <input type="checkbox"/> DOUBLE SET <input type="checkbox"/> OTHER _____	<input type="checkbox"/> 4 x 6 (Standard Size) <input type="checkbox"/> 5 x 7 <small>If nothing is selected, 4x6 prints will be produced. If 5x7 prints are selected, additional charges may apply and may require more time.</small>	<input type="checkbox"/> GLOSSY (Standard) <input type="checkbox"/> LUSTRE <small>If nothing is selected, Glossy prints will be produced. Lustre may require more time.</small>
7 OTHER SERVICES *For reprints or enlargements please use form on inside flap			
<input type="checkbox"/> REPRINTS / ENLARGEMENTS* <input type="checkbox"/> ANNOUNCEMENT CARDS <input type="checkbox"/> PREPRINTS FROM SLIDES These services require more time. See technician for more details.			
SPECIAL INSTRUCTIONS		LAB USE ONLY	
		TIME DUE:	
called on _____		called on _____	



РИЧ ЧАРАЦТЕР

ГЕНЕРОУС ФЛАВОР

ГОЛД

ПЕТРОВИЦ

ВОДКА

40% alc by vol

750ml / 80 Proof

ФИНЕСТ РУССИАН ИНГРЕДИЕНТС

ЩИНТЕР ИН СТ. ПЕТЕРСБУРГ

7 33608392

GOVERNMENT WARNING: (1) According to the Surgeon General, women should not drink alcoholic beverages during pregnancy because of the risk of birth defects. (2) Consumption of alcoholic beverages impairs your ability to drive a car or operate machinery, and may cause health problems.

BRUTE

PREMIUM TEQUILA

70% ALCOHOL BY VOLUME

100 PROOF

AGED REPOSADO

9 1774566 1679000

BRUTE

PREMIUM TEQUILA

100 PROOF

70% ALCOHOL BY VOLUME

IMPORTED BY:
FOX INTERNATIONAL BEVERAGE COMPANY

BRUTE PREMIUM TEQUILA HAS BEEN MADE THE SAME WAY BY THE SAME FAMILY FOR THE LAST 120 YEARS. EVERY DROP OF OUR AWARD WINNING TEQUILA IS AGED IN OUR PRIVATE CELLAR IN NEW AMERICAN AND FRENCH OAK BARRELS UNTIL IT REACHES OUR STANDARD OF EXCELLENCE.

GOVERNMENT WARNING: (1) According to the Surgeon General, women should not drink alcoholic beverages during pregnancy because of the risk of birth defects. (2) Consumption of alcoholic beverages impairs your ability to drive a car or operate machinery, and may cause health problems.

AGED REPOSADO







Model TX-210

AM/FM Electronic Clock Radio

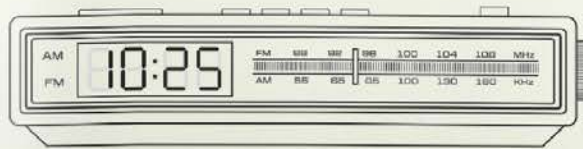

- SLIDE-RULE TUNER
- LARGE DIGITAL LED TIME DISPLAY
- MUSIC OR BUZZER ALARM
- SNOOZE BUTTON
- TWIN DYNAMIC SPEAKERS
- SLIDE CONTROLS FOR VOLUME
- TONE AND BALANCE CONTROL

INTRODUCTION

Your new AM/FM ELECTRONIC CLOCK RADIO is an especially designed all solid state precision instrument which, with proper care, will give you years of trouble free service. Please read these operating instructions carefully, as they will help you to obtain maximum performance from this excellent instrument.

WARNING: TO PREVENT FIRE OR SHOCK HAZARD, DO NOT EXPOSE THIS APPLIANCE TO RAIN OR MOISTURE.

Made in Singapore
MODEL NO. TX-210A
 WALNUT GRAIN FINISH
 ON POLYSTYRENE

COMPLIES WITH FCC
 REGULATION PART 15-C

120 VOLTS AC 60 HERTZ
 7 WATTS INPUT

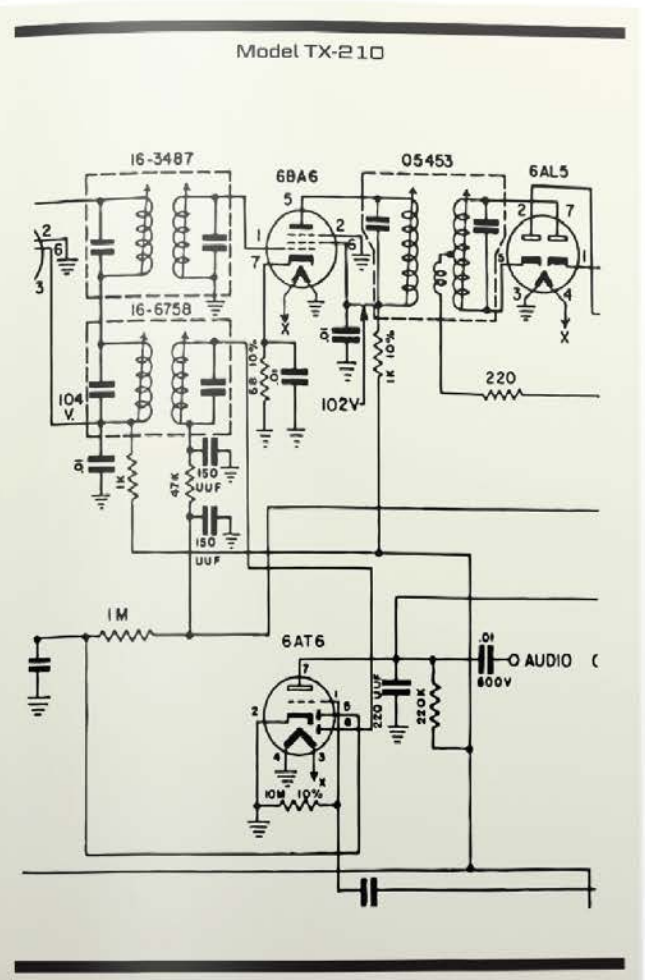
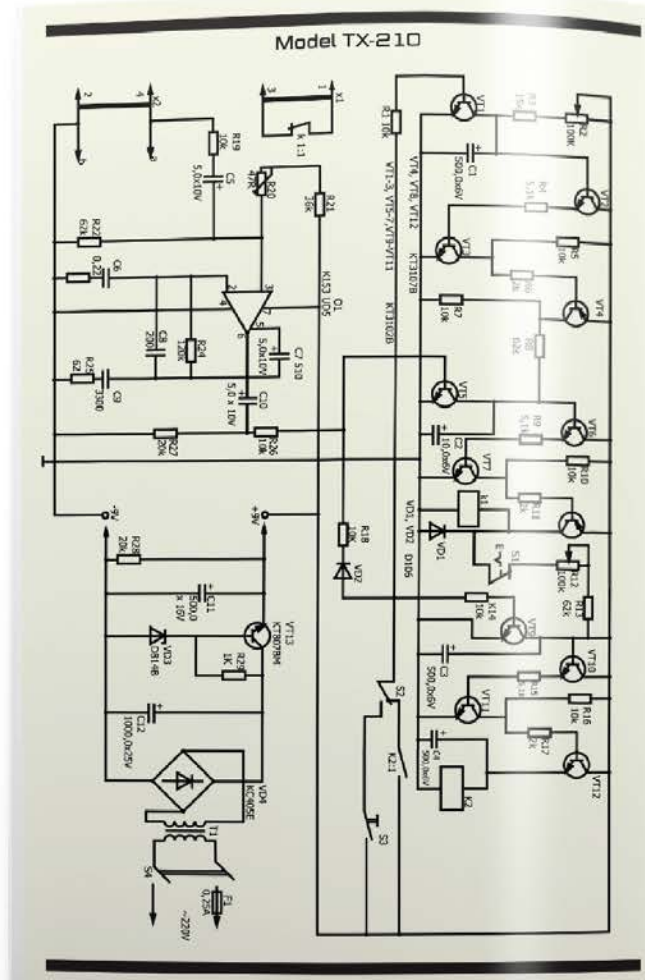

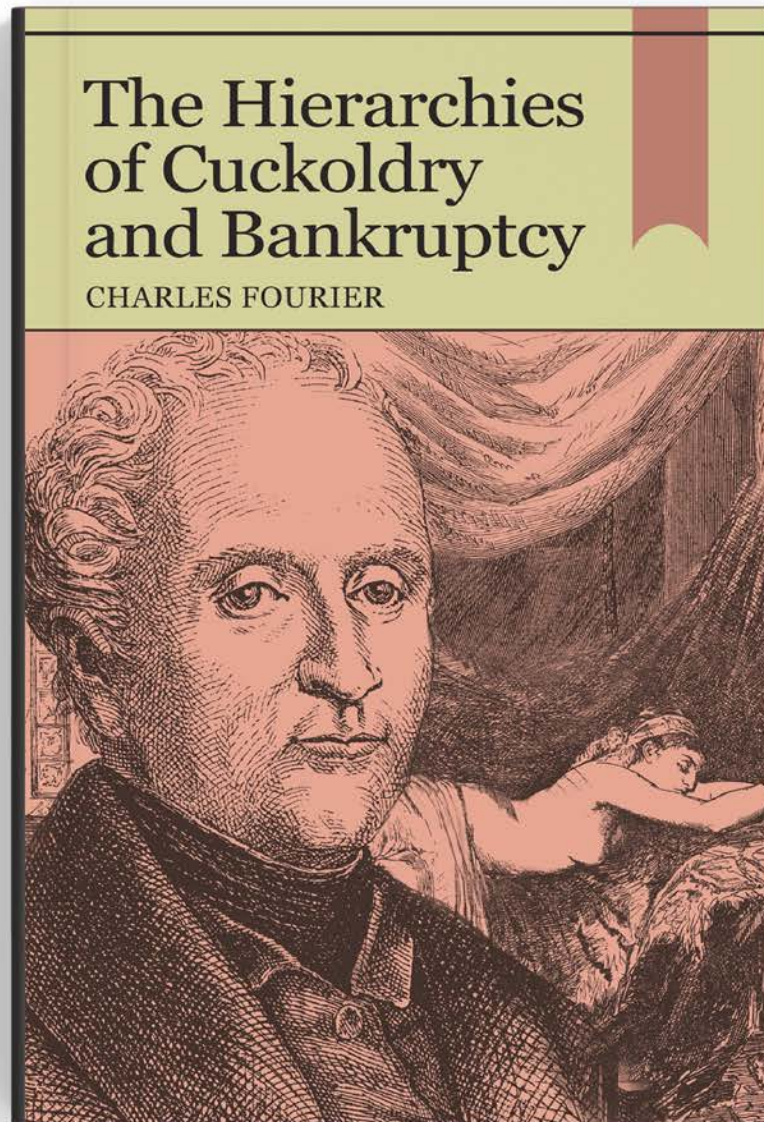

The Hierarchies of Cuckoldry and Bankruptcy

In this zoological guidebook to cuckoldry and commerce, Charles Fourier (1772-1837) offers a caustic critique of the bankruptcy of marriage and the prostitution of the economy, and the hypocrisies of a civilization that over-regulates sexual congress while allowing the financial sector to screw over the public. Gathered together here for the first time are Fourier's two "Hierarchies" - humorously regimented parades of civilization's cheaters and cheated-on in the domestic sphere of sex and the economic sphere of buying and selling commodities. "The Hierarchy of Cuckoldry" - translated into English for the first time - presents 72 species of the male cuckold, ranging from such "common class" cases as the Health-Conscious Cuckold, to the "short-horned" and "long-horned" varieties of the Sympathetic, Optimist, and Mystical Cuckold, and the irate, Disgraced, and Posthumous Cuckold. For Fourier, these amount to 72 manifestations of women's "secret insurrection" against the institution of marriage. "The Hierarchy of Bankruptcy" presents 36 species of the fraudulent bankrupt: a range of Light, Grandiose, and Contemptible shades of financial manipulators who force creditors, cities, and even nations to bail them out of ultimately profitable bankruptcies. In these attacks on the morality of monogamy and the perils of laissez-faire capitalism, Fourier's "Hierarchies" resonate uncannily with our contemporary world.

IBDN 0 224 0194 8

**Anyone can build a car.
Only Pontiac can build a GTO.**

The all new 1968 Pontiac GTO is not for every driver. It's unlike any car you've driven before, and for good reason. Not everyone can handle a car with this much power at their fingertips. That's because there aren't many cars on the market today that can stand toe to toe with the all new, more powerful Pontiac GTO.

Drive this car for yourself and you will find out what a 400 cubic-inch, 4 barrel V-8 really feels like. It's no surprise the GTO has been named "Car of the Year" more times than we can count. Drive it and you won't forget it. See your official Pontiac dealer to experience it for yourself.

JUN 26, 1968 FIFTY CENTS

TIME

THE SOUND OF SOUL



Singer
Aretha
Franklin

all new for 1968 **Pontiac GTO**

SONG HITS

MAGAZINE A Charlton Publication

CDC 35¢ JULY

WORDS
TO THE TOP
HIT SONGS
OF THIS
MONTH!



POP: UP THE LADDER TO THE ROOF
INSTANT KARMA

GOTTA GET BACK TO YOU
AMERICAN WOMAN

LET'S GIVE ADAM AND EVE ANOTHER
CHANCE

STIR IT UP AND SERVE IT
TAKE A LOOK AROUND • WHO'S YOUR BABY

Soul: CALL ME
TO THE OTHER WOMAN

THE BELLS
YOU'RE RIGHT, RAY CHARLES

GOT TO HOLD ON TO THIS FEELING
IT'S A NEW DAY PT. 1

KENTUCKY RAIN
COME INTO MY LIFE

COUNTRY: PLEASE BE MY NEW LOVE
WHERE GRASS WON'T GROW

WE'RE GONNA GET TOGETHER
I KNOW HOW

LORD IS THAT ME
MY WOMAN, MY WOMAN, MY WIFE

LIVE IS A SOMETIMES THING
YOU GOTTA HAVE A LICENSE



ARETHA FRANKLIN

STEPPENWOLF • BOBBY GOLDSBORO

OVER 60 Top Tunes !!





TOUR #1

STATUE OF LIBERTY & BOAT RIDE

About 6 hours

The Grand Combination of Tour #3 and #5, (as described in this folder under Tour #3), covering the many fascinating land features of the City in the Downtown and Uptown areas is seen in its entirety, in addition, the passenger on this tour will be provided with the boat ride across the harbor to the Statue of Liberty and the one hour visit there, as described in Tour #4.

April 1 thru October 31

9:00 AM, 10:00 AM
11:15 AM, 12:15 PM
1:15 PM, 2:15 PM
3:15 PM & 4:15 PM

SIGHTSEEING SIGHTSEEING

NEW YORK CITY

NEW YORK CITY



THE BEST GUIDED TOURS

600 W 250th Street
New York, NY



Phone: 212-136-5930

967 East 9th Street
New York, NY

600 W 250th Street
New York, NY



Phone: 212-136-5930

967 East 9th Street
New York, NY



01 6168
 PURCHASED 07/04/03
 266423465 2427308

Long Island Rail Road **1 2 3 4 5 6 7**

Flower Hill **4**
 Penn Station **1**

R/T Peak

Subject to applicable tariff regulations and conditions of use. Non transferable.

Good for 2 Rides in either direction for 3 months from date of purchase. Not redeemable after 3 months from date of purchase.

MC4 105162
 07/04/03
 CASH \$20.00 4004 40101 12549468678

01 6168
 EXPIRES 07/04/04
 52468843 77324567

Long Island Rail Road **1 2 3 4 5 6 7**

Flower Hill **4**
 Penn Station **1**

Monthly JUN

Subject to applicable tariff regulations and conditions of use. Non transferable.

Subject to \$10 refund fee

Good for 2 Rides in either direction for 3 months from date of purchase. Not redeemable after 3 months from date of purchase.

MC9 105162
 07/04/03
 CASH \$2035.00 5631 62204 62457889824

PROVIDED COMPLIMENTARY BY

MONCRIEF FUNERAL HOME

AIR CONDITIONED
MEMPHIS, TN

Funeral Services



DIAL 4417



Ambulance Service

DIAL 4417

IN CASE OF ACCIDENT SEE LAST PAGE OF CALENDAR

FEBRUARY		MARCH					APRIL	
1 2 3 4 5 6 7		1942					1 2 3 4	
8 9 10 11 12 13 14							5 6 7 8 9 10 11	
15 16 17 18 19 20 21							12 13 14 15 16 17 18	
22 23 24 25 26 27 28							19 20 21 22 23 24 25	
26 27 28 29 30							26 27 28 29 30	
SUN.	MON.	TUE.	WED.	THU.	FRI.	SAT.		
1	2	3	4	5	6	7		
8	9	10	11	12	13	14		
15	16	17	18	19	20	21		
22	23	24	25	26	27	28		
29	30	31	NEW MOON 	FIRST QUARTER 	FULL MOON 	LAST QUARTER 		

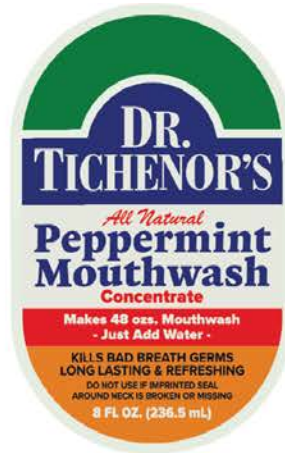

BUFFALO TELEPHONE



Dial direct — MOST SUBURBS and Buffalo

- Remove receiver — deposit a DIME or two nickels.
- Listen for dial tone — dial the number.
- For calls beyond service area — additional amount will be requested after you dial.
- If no answer, hang up, money will return.

10¢

	Emergency "0" Long Distance "311" Operator "0" Repair Service. "811"
---	---



Rx

SHELTON'S PHARMACY

DETROIT, MI LICENSE # 98298-0072

CLARENCE L. FRANKLIN

SODIUM BICARBONATE 25MG
TAKE 2 DROPS IN MORNING
OR AS DIRECTED BY DR.

DR. K. SUFFIELD, M.D.

USE PRESCRIPTION AS DIRECTED - IT IS A VIOLATION OF FEDERAL LAW TO DISPENSE PRESCRIPTIONS TO INDIVIDUALS OTHER THAN THE PERSON IT WAS PRESCRIBED TO.



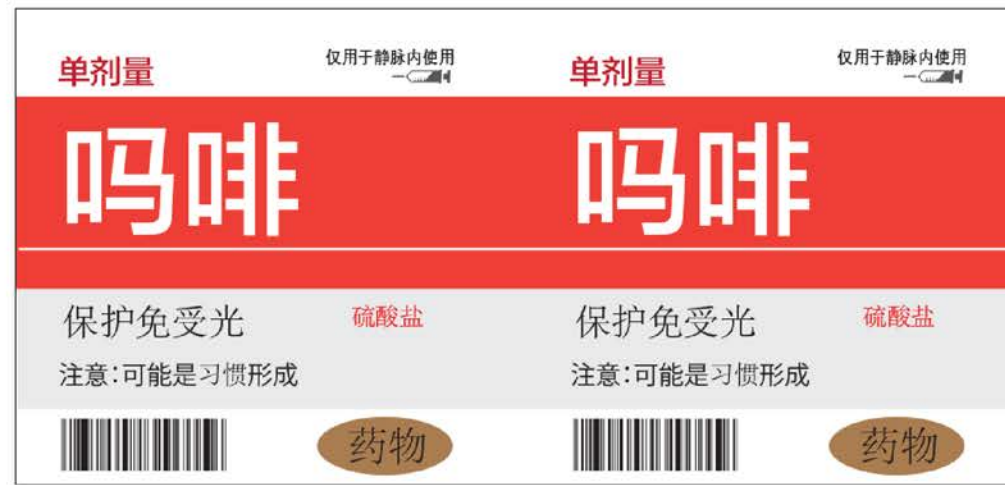

Florida *The Sunshine State*



DRIVER LICENSE
4476-D49-715-0



JIM JIAN SENG
2559 MILLEREDGE AVE.
JACKSONVILLE, FL 32209

DOB **11/19/1951**
ISSUED **12/12/2001**
EXP **12/12/2011**

SEX **M** HEIGHT **6' 0"** EYES **BRN**
CLASS **D**



72841-N

NEW JERSEY *Motor Vehicle Commission*

AUTO DRIVER LICENSE



COMMISSIONER OF MOTOR VEHICLES

9587581557 CLASS **D**
DOB **01/03/1956**



FRANCES B. PETERSON
855 OGRADY COURT,
TEANECK, NJ 07666

ISSUED **10/30/1995**
EXPIRES **10/30/2005**

SEX **F** HEIGHT **5' 02"** EYES **BRN**

ORGAN DONOR

NEW YORK STATE *Ronald Blinn*
DRIVER LICENSE Commissioner of Motor Vehicles

DL **7554D1346** Class **D**
Exp **08/16/2010**



NGUYEN, WALTER G.
567 BAYARD ST.
NEW YORK, NY 10013

DOB **05/16/1964**
Issued **08/16/2005**

Sex **M** Height **5' 09"** Eyes **BRN**

E NONE
R NONE



44861-N

Pennsylvania **DRIVER'S LICENSE**



DL **5567D1497**
DOB **04/15/1958**
Exp **06/04/2005** Issued **06/04/2000**

GALVEZ, PEDRO I.
125 PARK W BLVD.
WATKINSVILLE, PA 16803

Sex **M** Height **5' 08"** Eyes **BRN**
Class **D**



44861-N



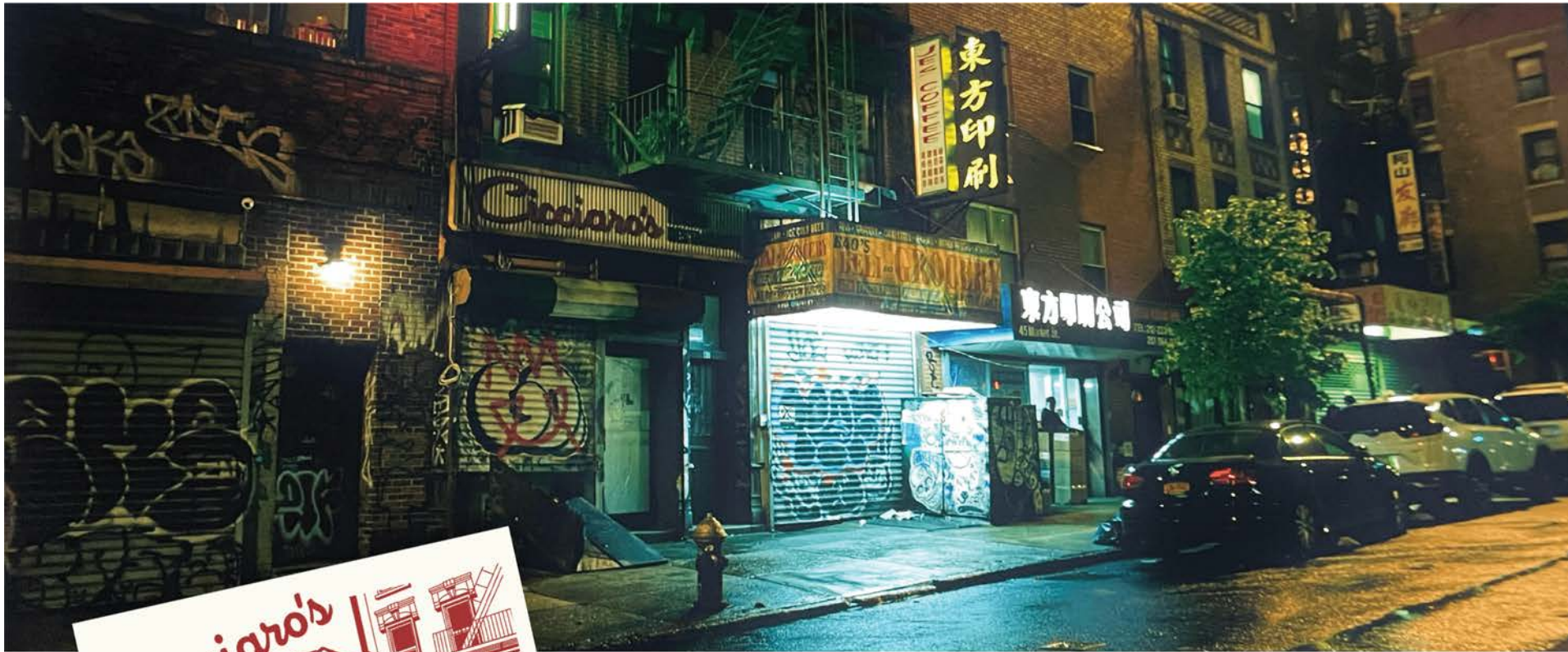

ITALIAN RESTAURANTE
Cicciano's

REGAL | **FRI. SEPT. 27**
 ADMISSION \$3.50 - \$4.50 - \$5.50
 TICKETS ON SALE AT BOX OFFICE
 FREE LIGHTED PARKING! 8:30 P.M.

IN CONCERT

"NATURAL WOMAN"
Aretha FRANKLIN
 "THINK"
REVUE

"CHAIN OF FOOLS"
 "BABY, BABY, BABY"
 "RESPECT"
 "PROVE IT"
 "TAKE A LOOK"

AND
ORCHESTRA

Bill **HALEY**
 AND HIS COMETS
 IN
 "The" **"BIG SHOW"**
LaVern Baker

Freddie Bell
 and **THE BELLBOYS**

Joe Turner

1ST AUSTRALIAN TOUR 1957

Auditorium
 KLAMATH FALLS, OREGON
SAT. AUG. 6th
 Dancing 9 p.m. to 1 a.m.

IN PERSON...
 "Lonely Winds"
 "Dance With Me"

THE... DRIFTERS
 "This Magic Moment" "There Goes My Baby"
 WITH.....

DOC BAGBY
 and his orchestra

"GRINDING" "DUMPLINS"

ARETHA FRANKLIN
 LIVE PRESTEREN MET
SWEET INSPIRATIONS
CONCERTGEBOUW AMSTERDAM
 ENTREEPRIJZEN F 6.00, F 8.-, F 15.- EN F 16, VESTIARE EN PLAATSBESPREKING INBEGREPEN
 MEI 1968 - 19.00 UUR S AVONDS

AFTER TURKEY HOP
 FRIDAY, NOVEMBER 28TH
 Coliseum Ballroom — Davenport, Iowa
 \$1.75 In Advance — \$2.00 At Door

Ruth **BROWN**
 In Person
 The "Mama Girl"

"THIS LITTLE GIRL'S GONE ROCKIN"

NEW HITS!
 "Lucky Lips"
 "5-10-15 Hours"

WITH **PAUL WILLIAMS**
 HUCKLEBUCK ORCH.

Ray **CHARLES**

Sensational Vocalist-Pianist

- * "IT SHOULD'VE BEEN ME"
- * "THIS LITTLE GIRL IS MINE"
- * "I'VE GOT A WOMAN"
- * "A FOOL FOR YOU"
- * "COME BACK"

"DROWN IN MY OWN TEARS"

AND HIS **ORCHESTRA**
 ATLANTIC RECORDS

SUNDAY **OCT. 12** | **SUNSET**
 9:30 P.M. 'Til 1 A.M.
 Adv. \$1.75 (Tax Incl.)
 Door \$1.98

Joe MORRIS

ATLANTIC RECORDING STAR
 "YEAH! YEAH! YEAH!"
 "MY LOVE, MY DESIRE"

CREATOR OF
 "PLEASE DON'T TAKE YOUR LOVE AWAY"
 "ANYTIME, ANYPLACE, ANYWHERE"
 "LET'S HAVE A BALL TONIGHT"

AND HIS CAVALCADE OF BLUES
ORCHESTRA

Plus **LOWELL FULSON**
 "BLUE SHADOWS" "OLD TIME SHUFFLE"

ZEBRA LOUNGE
 CENTRAL AT MANCHESTER
 PRESENTS

RAY CHARLES

10 Days Only
 Starts **THURS. JUNE 1**

OFF NIGHT
 TUES. JUNE 6

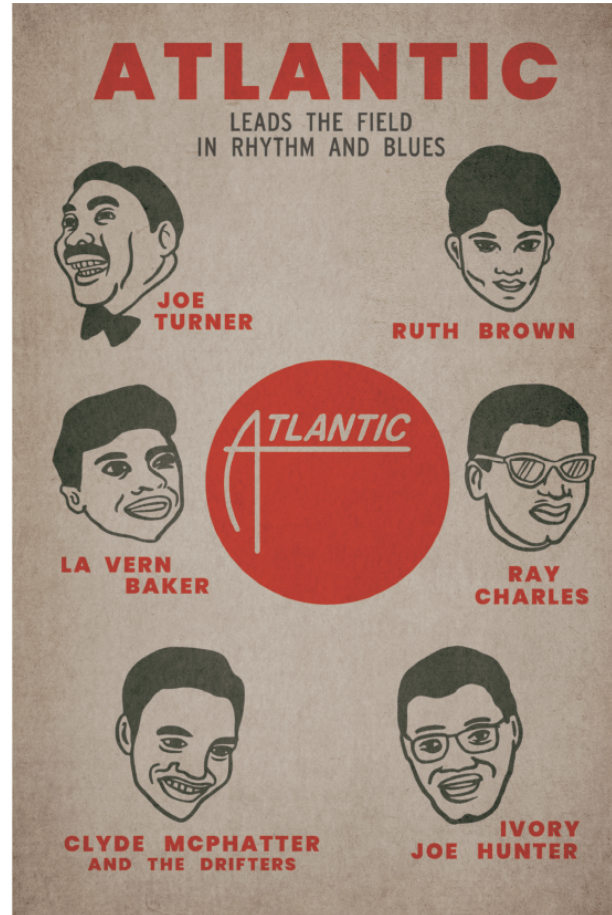



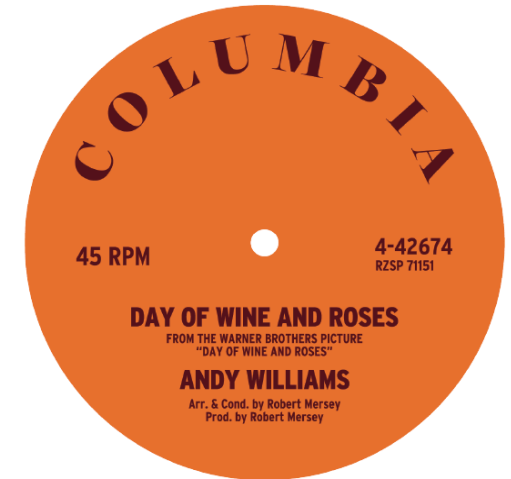







HOMETOWN TRIBUTE

**ARETHA
FRANKLIN
DAY**



aretha

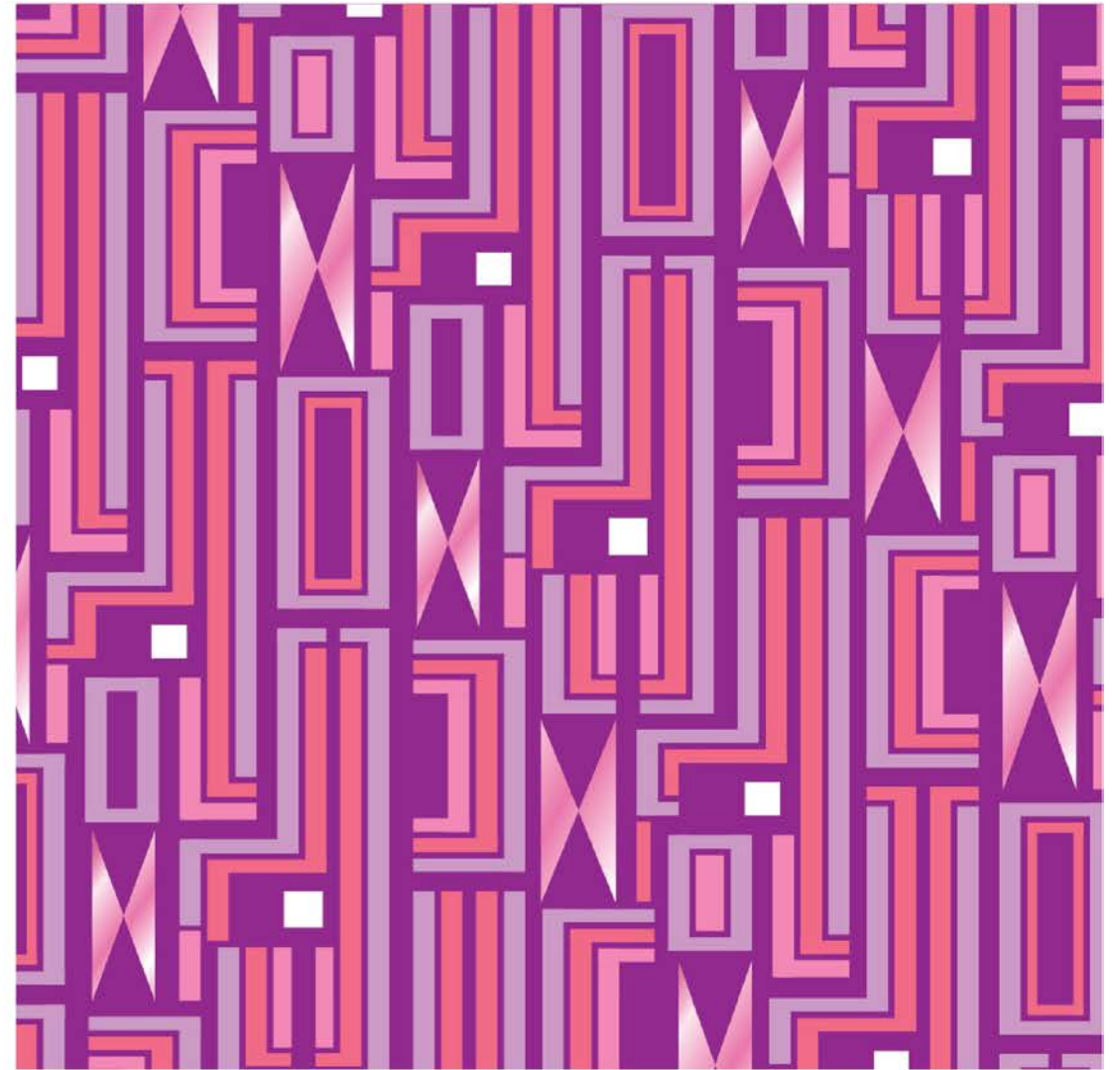
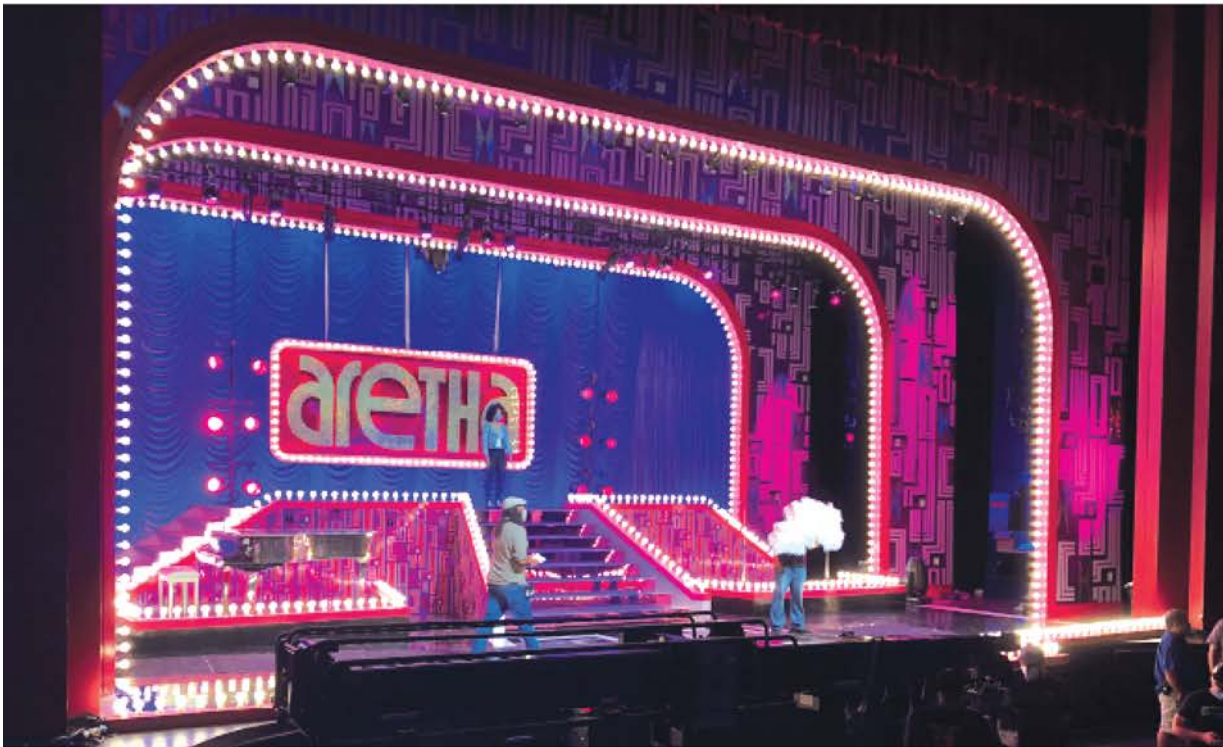



the
steve
allen
show

Steve Allen





BRUCE ELLEN
1892 1961 1880 1962
BUTLER

GARY THOMAS ELIZABETH GRACE
1908 1996 1903 1990
KUGLER

FRANCESCO ANTON ANITA
1920 1994 1921 1991
BARBIGILA

CLARA ALBERT
1923 1996 1920 1993
WHITLOCK

REV. C. L. RACHEL PITTMAN
1915 1984 1897 1988
FRANKLIN

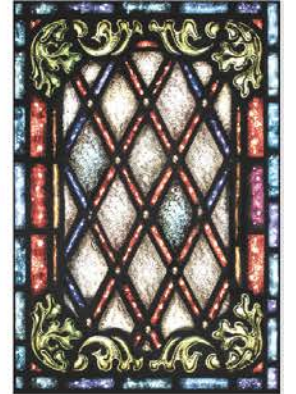



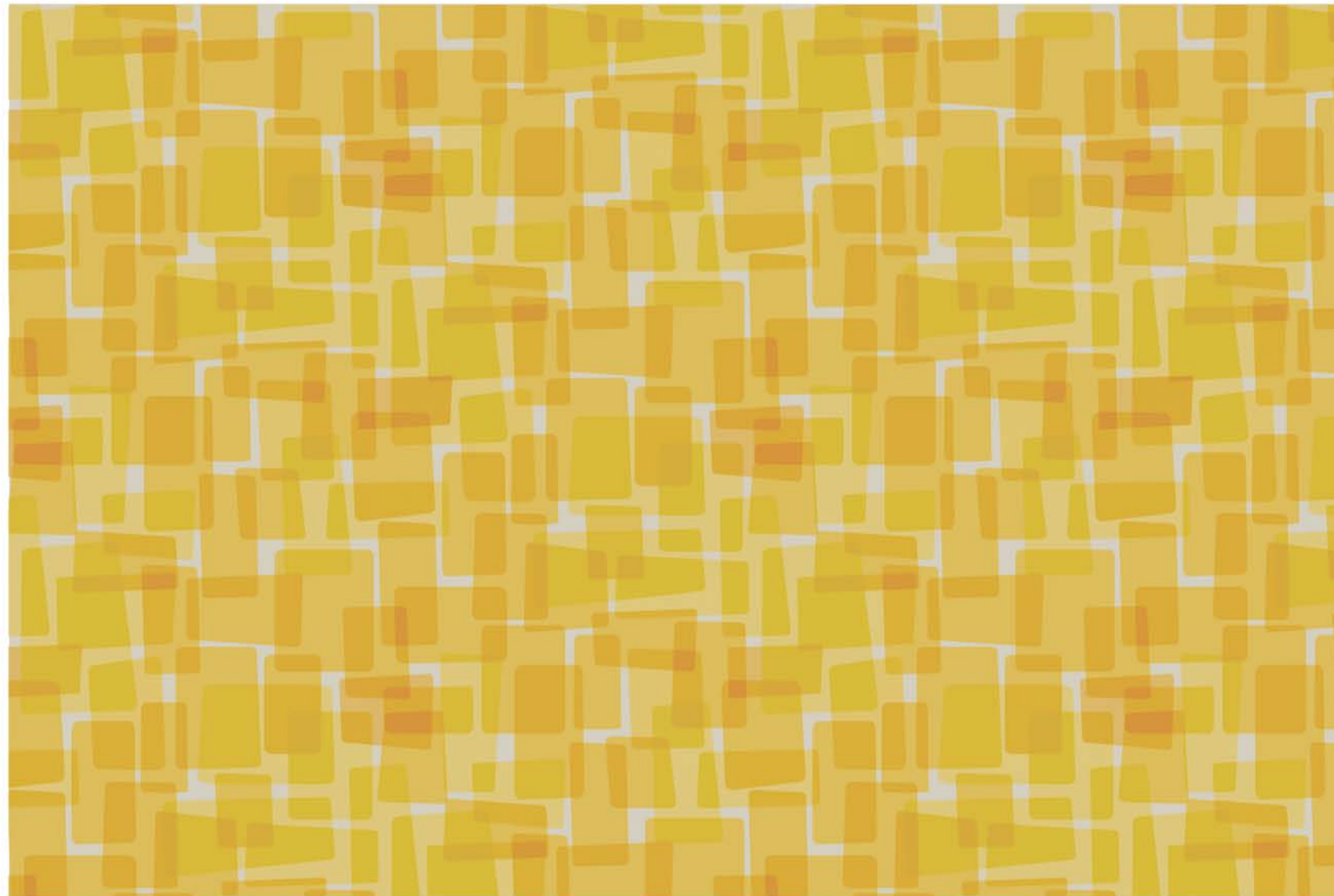



Bathroom Hydrangea Print



Monkey Print Wallpaper

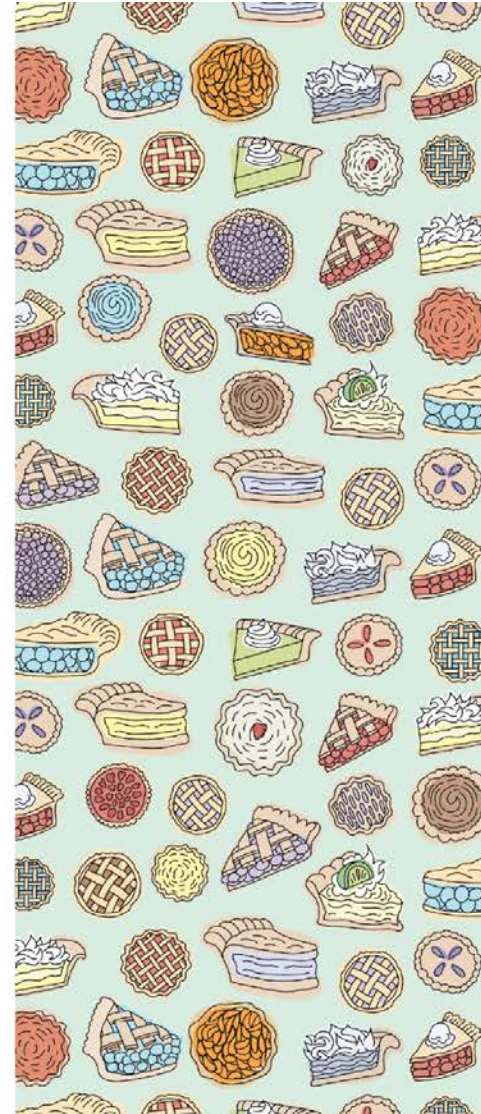

Illustrated Pie Wallpaper

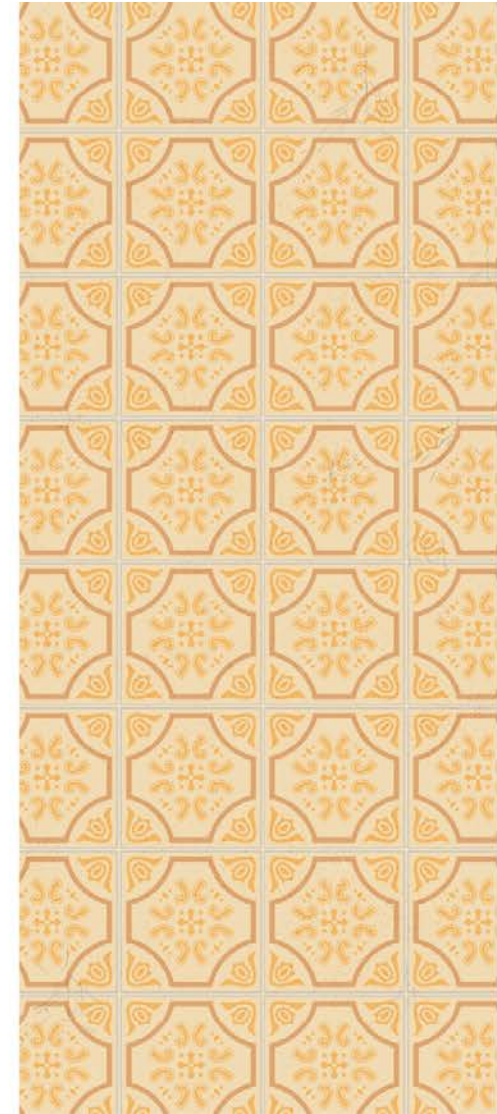

1960's Linoleum Pattern Reproduction





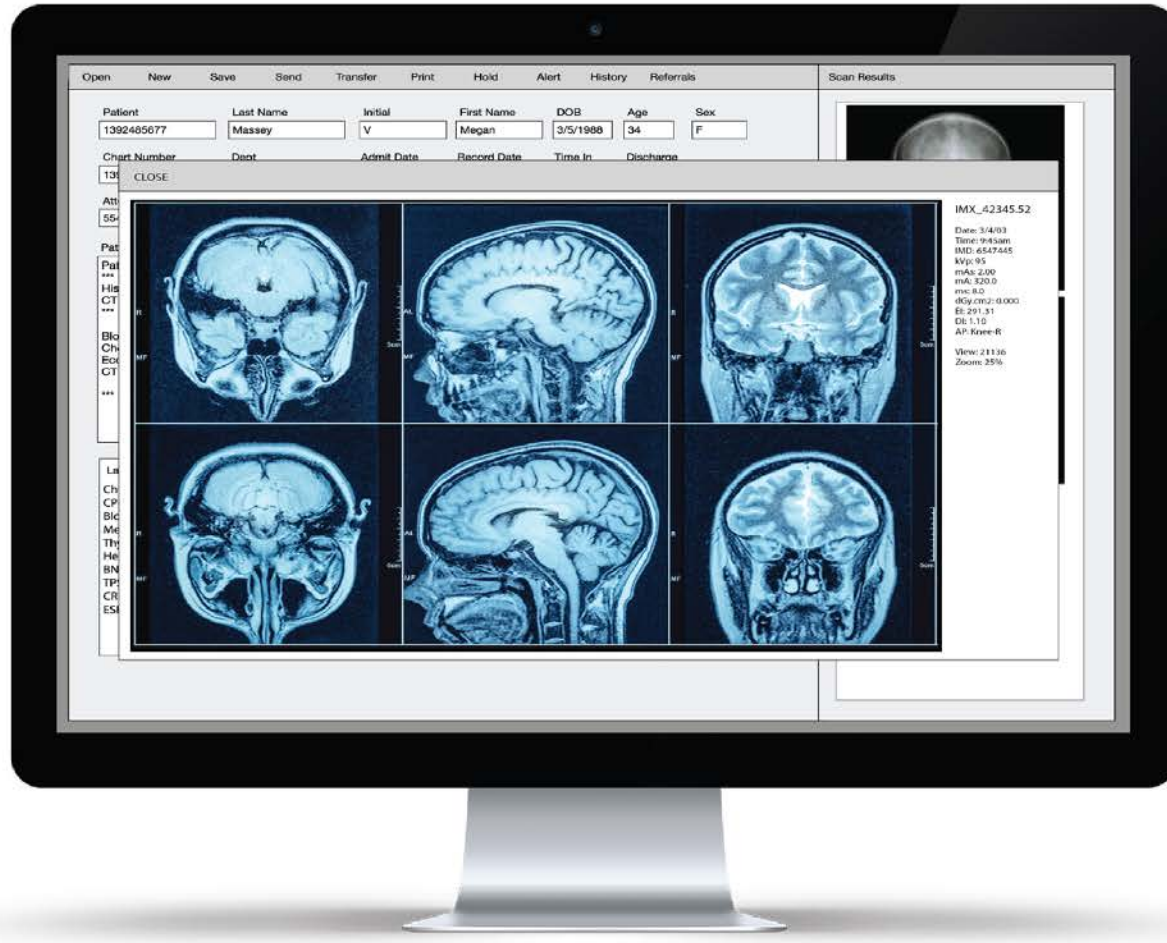

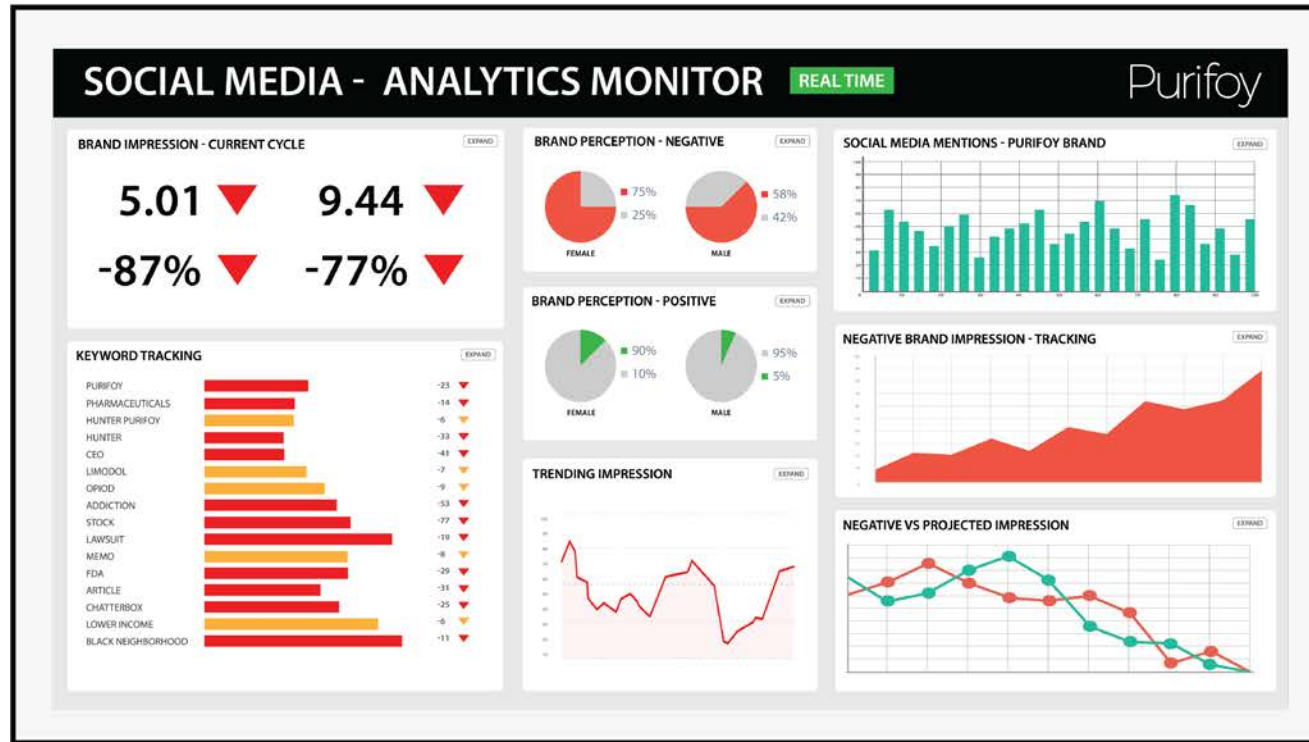

ROOM	ATTENDING M. D.	NURSE	NEXT ROUND	NEXT PAIN MEDICATION	FALL RISK	PROCEDURE	TRENDING PAIN	ALARM
E3	KINNEY, S	TRACEY	12:30 PM	2:00 PM	HIGH		2 +5	●
E11	KINNEY, S	TRACEY	3:00 PM	2:00 PM	HIGH	Labs	2 +5	●
E7	KINNEY, S	TRACEY	3:05 PM	2:00 PM	LOW		3 +2	●
E13	KINNEY, S	ELLA	4:00 PM	2:15 PM	LOW	Discharge, Edu.	6 +1	●
E19	HILL, B.	ELLA	1:00 PM	2:15 PM	LOW		2 +3	●
E8	CIPRIANO, G	ELLA	2:00 PM	2:15 PM	HIGH	Consult, US	3 +1	●
E15	CIPRIANO, G	ELLA	4:20 PM	2:05 PM	HIGH		4 +1	●
E24	HILL, B.	ASHLEY	4:10 PM	2:05 PM	LOW	RT, Xray	1 +1	●
E4	HILL, B.	ASHLEY	1:37 PM	2:00 PM	LOW	OT, PT	1 +2	●
E20	HILL, B.	ASHLEY	3:45 PM	2:30 PM	LOW		9 +1	●
E10	HILL, B.	ASHLEY	2:00 PM	2:05 PM	HIGH	PT	5 +1	●
E6	KINNEY, S	ASHLEY	5:00 PM	2:00 PM	LOW	CT	4 +3	●
E26	KINNEY, S	ASHLEY	3:05 PM	2:30 PM	LOW		3 +1	●
E17	KINNEY, S	ASHLEY	1:25 PM	1:50 PM	HIGH	Care Conf, Labs	7 +1	●
E23	CIPRIANO, G	TRACEY	4:00 PM	2:00 PM	LOW	CT	2 +2	●
E16	CIPRIANO, G	TRACEY	5:00 PM	2:25 PM	LOW		1 +4	●
E9	CIPRIANO, G	MADLINE	2:25 PM	3:00 PM	HIGH	Consult, RT	3 +1	●
E18	CIPRIANO, G	MADLINE	6:30 PM	2:40 PM	HIGH	Labs	3 +1	●
E2	KINNEY, S	MADLINE	2:00 PM	4:00 PM	HIGH		7 +5	●
E14	CIPRIANO, G	TRACEY	5:45 PM	2:05 PM	LOW	Discharge, Labs	8 +1	●
E21	CIPRIANO, G	MADLINE	5:00 PM	2:00 PM	LOW	CT, Eco, Xray	10 +1	●
E22	KINNEY, S	MADLINE	2:00 PM	2:30 PM	HIGH		4 +2	●
E5	KINNEY, S	TRACEY	3:15 PM	2:05 PM	LOW	EVC, Chem	1 +1	●
E1	KINNEY, S	TRACEY	2:00 PM	2:00 PM	LOW	OT, PT	2 +3	●
E25	HILL, B.	ASHLEY	4:00 PM	2:30 PM	HIGH		3 +7	●
E12	HILL, B.	ASHLEY	1:45 PM	1:50 PM	LOW		1 +1	●

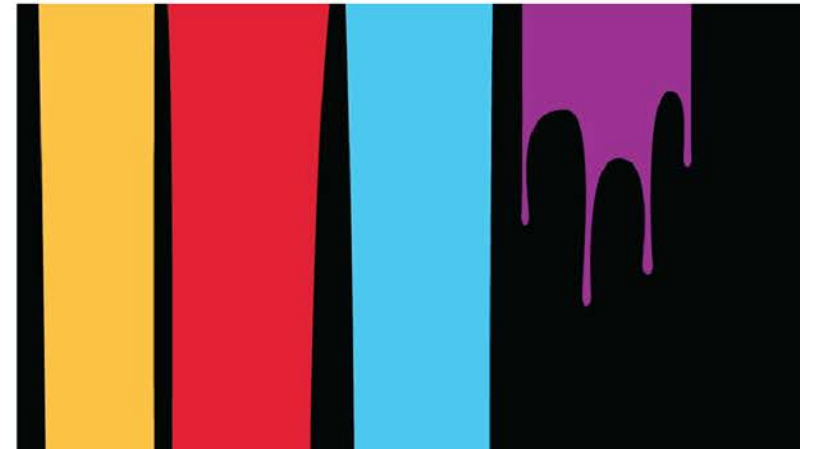
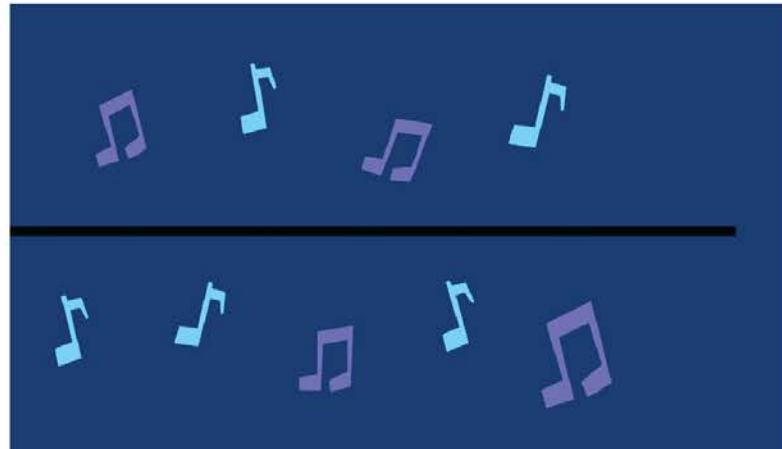
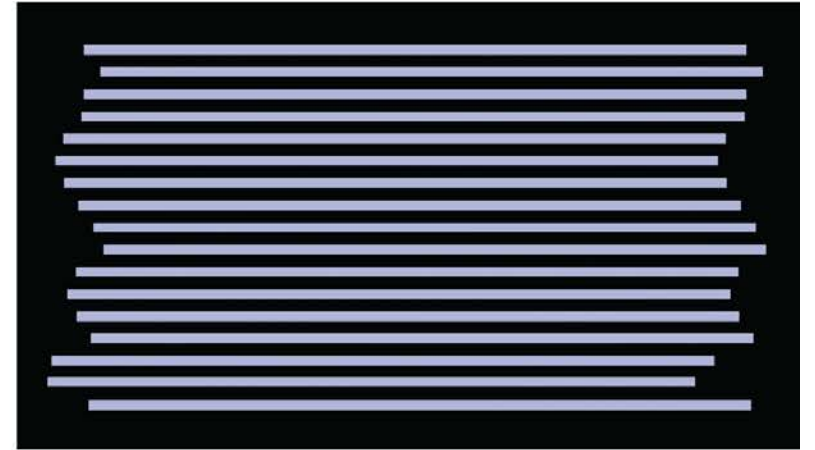
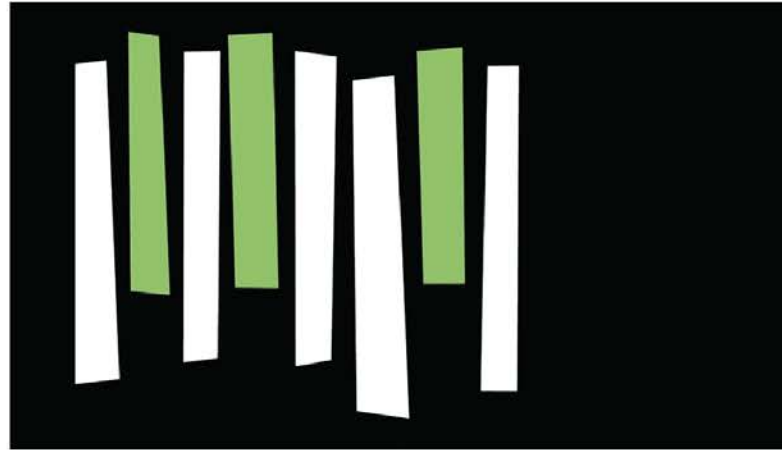

EXAMPLE 1

EXAMPLE 2

EXAMPLE 3

EXAMPLE 4

EXAMPLE 5

ORIGINAL

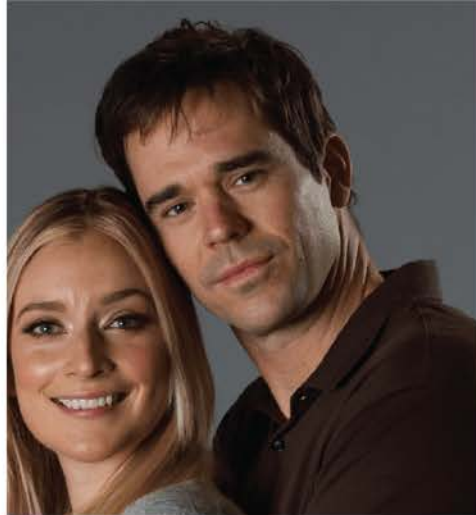

AGED DOWN

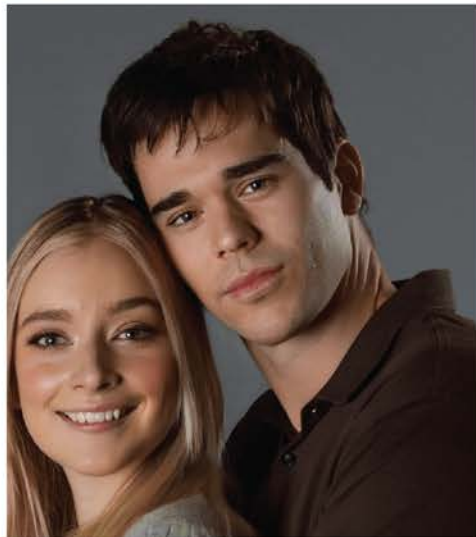

Thank You

KINNEYDESIGN.COM

404-725-5176

SCOTT@KINNEYDESIGN.COM